

RENO DESIGNED FOR 3" HIGH SINK SENSOR SOAP DISPENSER INSTALLATION INSTRUCTIONS



BEFORE YOU BEGIN

Before you begin, please read the installation instructions below. Observe all local building and safety codes.

Unpack and inspect the items for any shipping damages. If you find damages, do not install.

Please note all products must be installed by a professional and certified plumber otherwise warranty might be voided.

POSSIBLE TOOLS REQUIRED*



Plumbers Tape

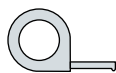

Tape Measure



Level

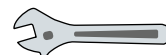

Adjustable Wrench



Hex Wrench



Thread Sealant



Drill



Pencil or Marker



Screwdriver

*not included

Specification	
Product Type:	Commercial
Main Construction Material:	Brass
Mount Type:	Deck
Soap Pump:	6 Volt Noise-Free
Power:	4 (D) Batteries / AC Adapter Optional
Batteries Required:	4 (D) Batteries (not supplied)
Number of Tap Holes:	1
Sensor type:	Active Infrared, Self-Adjusting
Sensing Range:	Adjustable with optional remote control
Sensing Range:	0 +8cm
Working Soap:	Standard liquid Soap.
Soap Bottle Capacity:	800ML (Just Under a quart)
Soap Amount Per Use:	0.5ML to 1.5ML, adjustable

Size

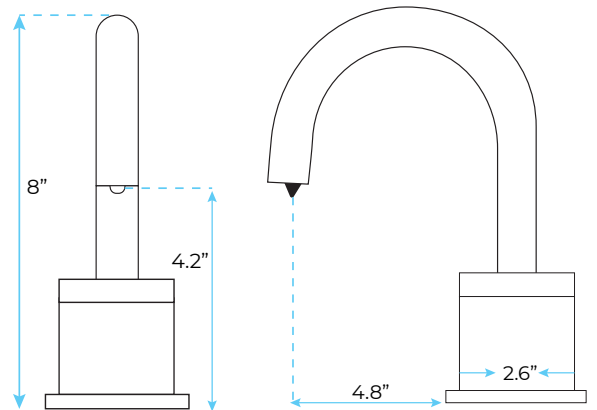

Deck Mount Installation

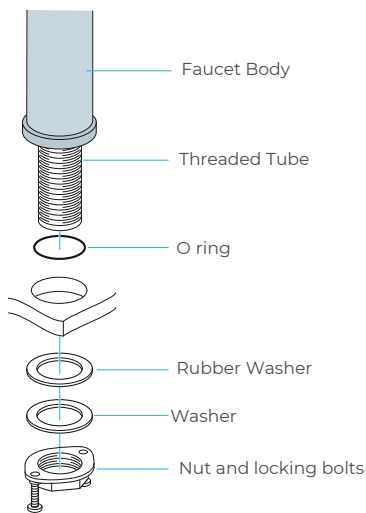

Hole Size Chart

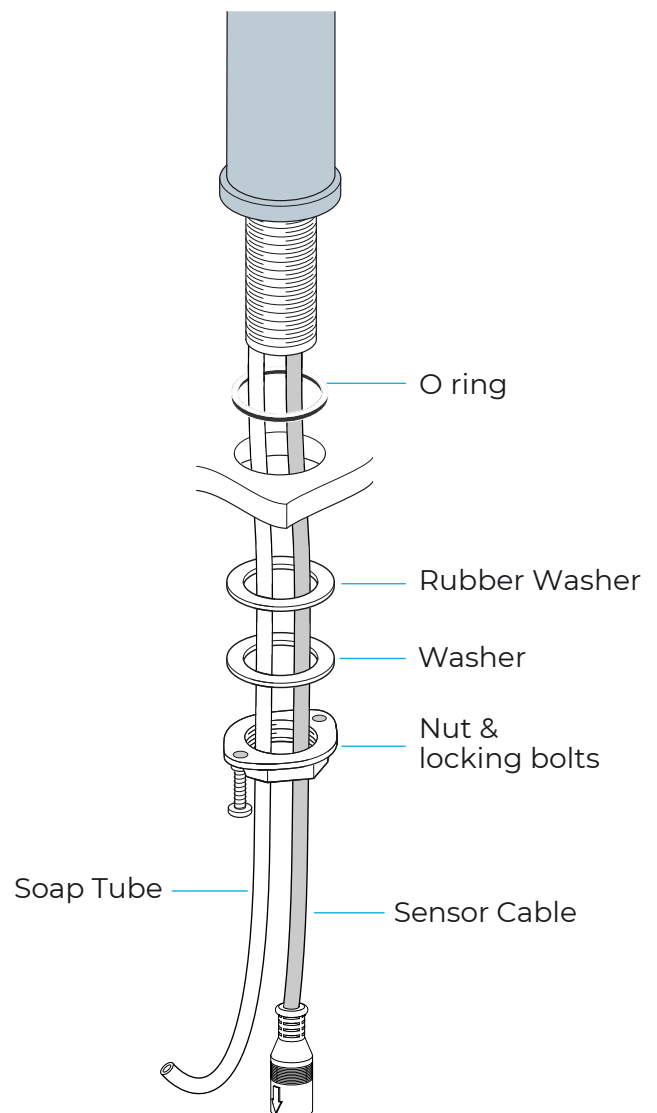
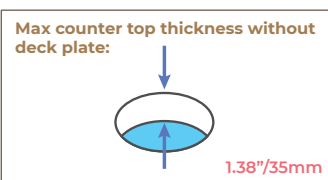
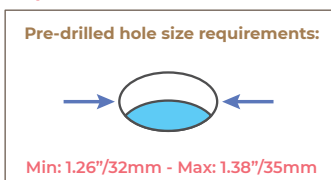
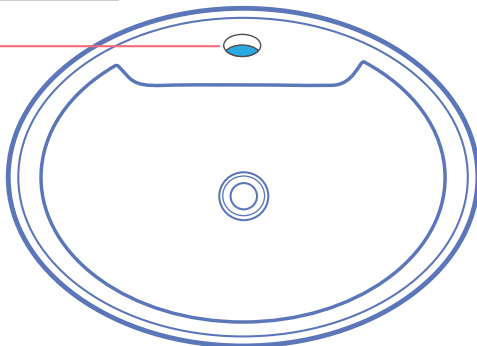

All dimensions and specifications are nominal and may vary. Use actual products for accuracy in critical situations.

Installation Method



Install the bracket on the wall



Insert the pump onto the bracket

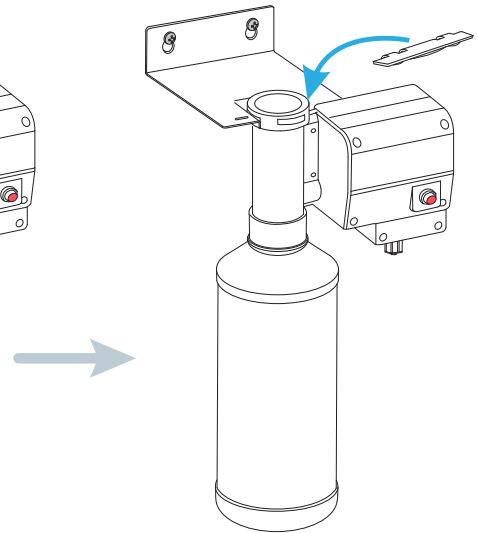

Insert the locking plate into bracket

Soap Refill Process

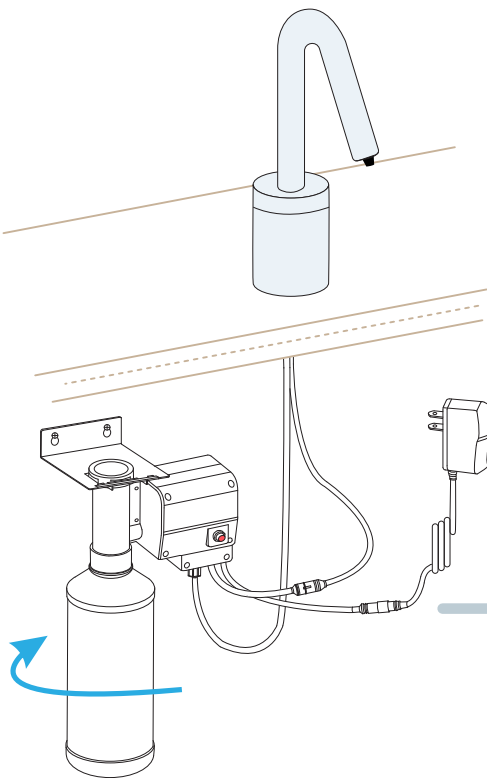

Unscrew the empty bottle.



Add soap into the empty bottle.

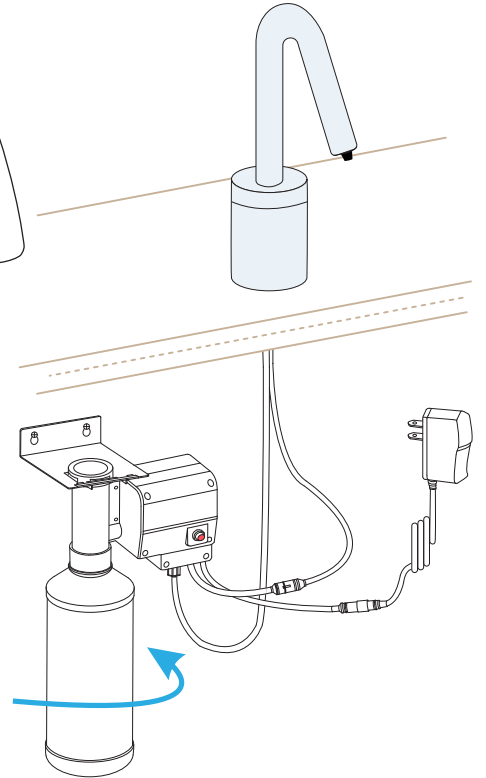

Affix the bottle with full soap onto the pump, and do not over tighten.

Deck Mounted Faucet

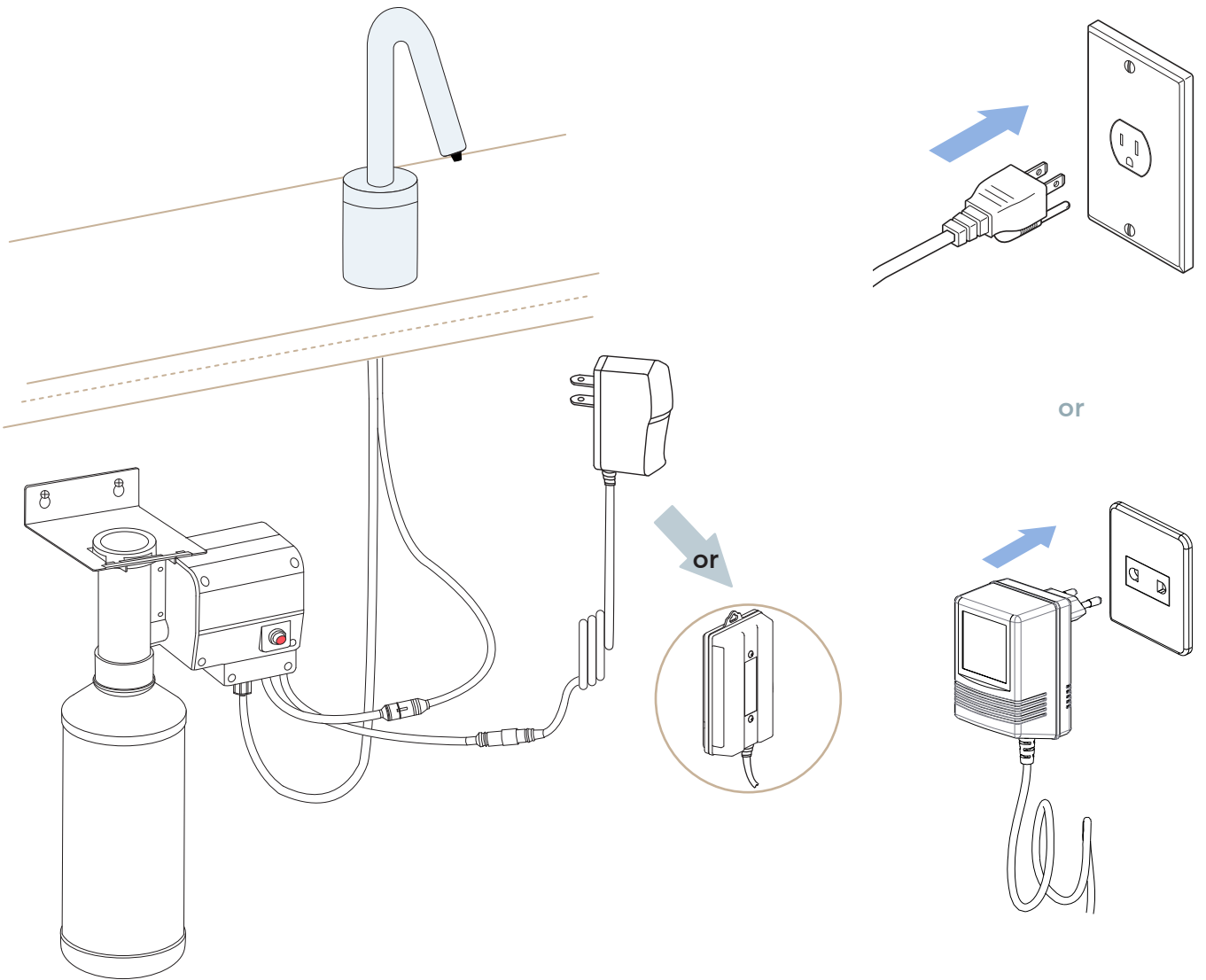

Battery Box

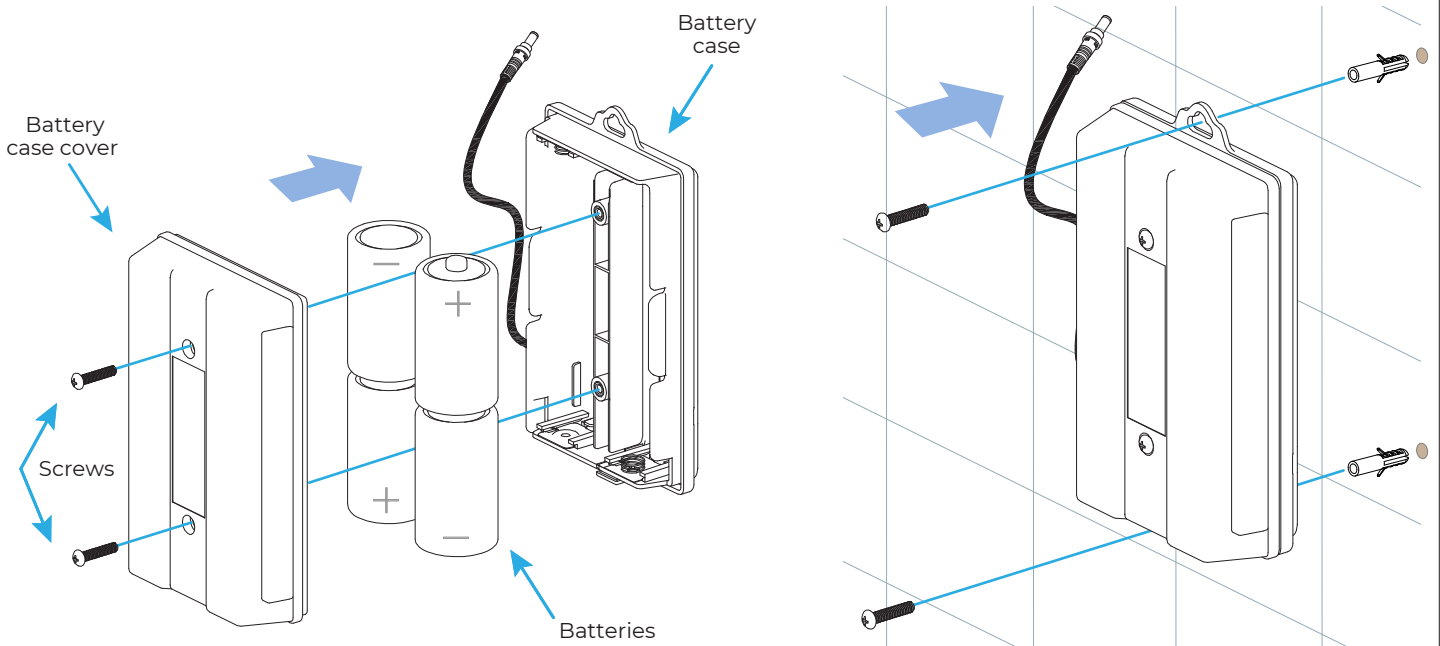

Fontana Sensor Faucets[®]

1. Remove cover of battery case.
 2. Install four (4) D size alkaline batteries.
Note: Make sure the batteries are installed in correct orientation (polarity).
 3. Replace battery case cover.
 4. Tighten screws.
- The standard life cycle time is 2 years, based on average use 2000 times/month.



Usage

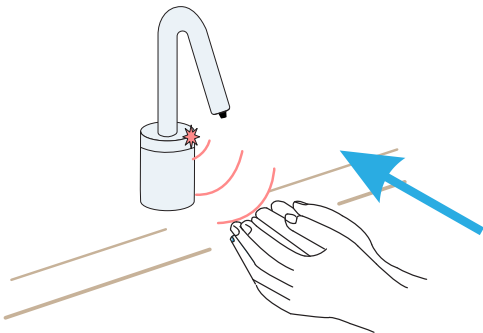

Place hands immediately under soap spout.

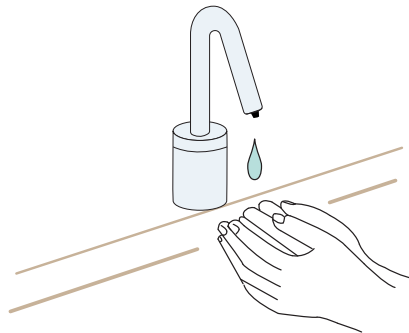

Predetermined amount of soap will dispense

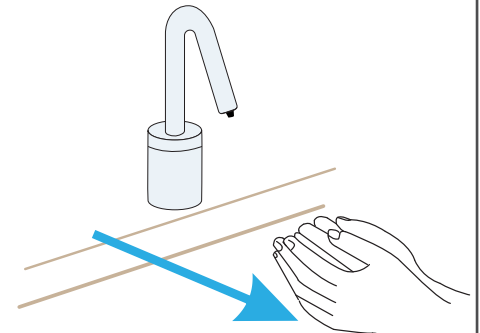

If more soap is needed, remove hands & repeat.

Usage of Button

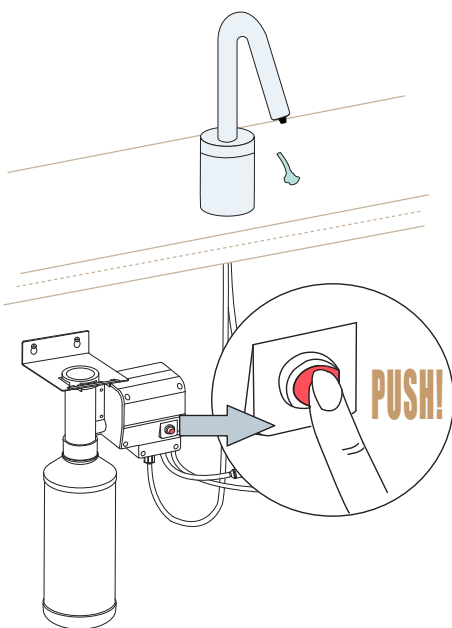

When the soap bottle is filled with soap, press the button till soap dispenses out of nozzle.

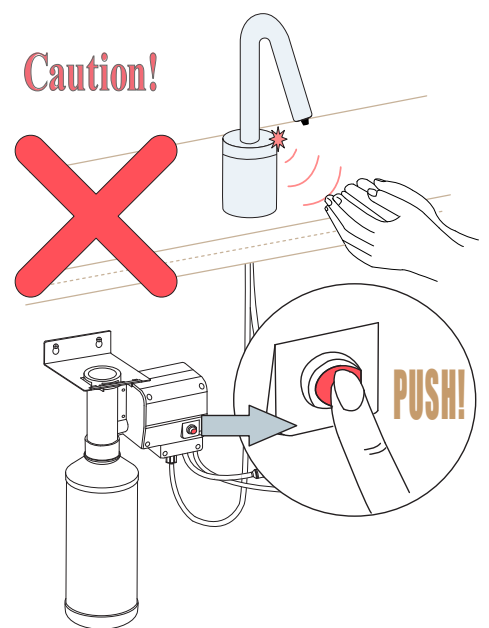
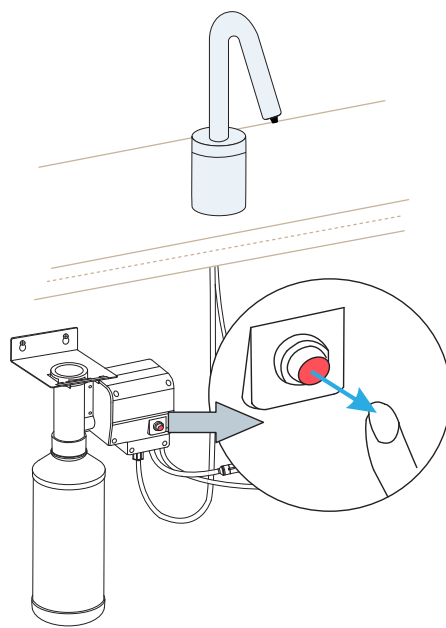

Do not use the sensor when the button is pressed, because they cannot be used at the same time, as it might lead to the damage to the machine.

Commissioning Sequence

Before using the soap dispenser for the first time the following sequence must be carried out.

Fill the bottle full of soap.

Locate the dispense button on the side of the pump. Press and hold the button until soap is dispensed from the spout. This will ensure the dispenser tube and cable are full of soap.

Operation

Place the hands under the spout within the sensing range.

Once the users' hands have been detected a small amount of soap will be dispensed from the spout into the users' hands.

General Information

Our sensor soap dispensers have a non-touch control which uses infrared sensing technology to detect human presence. Once detected, the spout instantly dispenses soap and automatically stops once the user moves their hands away to eliminate unnecessary wastage, whilst creating a more hygienic washroom solution.

All products manufactured and supplied by Fontana are safe and comply to legislative requirements. Providing they are installed correctly and receive regular maintenance in accordance with these instructions your user experience will not be affected.

Sensor Faucet & Soap Dispenser Installation

Incorrect Installation



Keep sensor range adjustment within 4 inches away from center of spout. This can only be done with optional remote control.

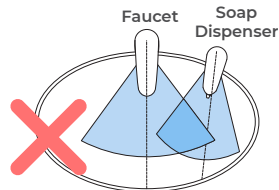

Installing electronic soap dispenser & faucet with intersecting centerline might lead to accidental activation of either or both.

Correct Installation



Keep sensor ranges factory preset.



Keep soap spout & faucet centerline parallel.

Care & Cleaning

- Wipe away any debris adhering to the spout or sensor.
- Wipe away debris with a damp cloth containing a suitable amount of a neutral, dishwashing detergent. Then wipe clean with a damp cloth.
- When cleaning around the sensor, please be careful not to scratch the surface of the sensor window.
- Do not use detergent that might damage the surface of spout. These include:
 - Detergents containing acid, chlorine bleach or alkali.
 - Detergents that are coarse granules in nature, such as polishing powder.
 - Solvents such as paint thinner or benzene.
 - Abrasive aids such as nylon scrubbers/brushes, steel wool, etc.

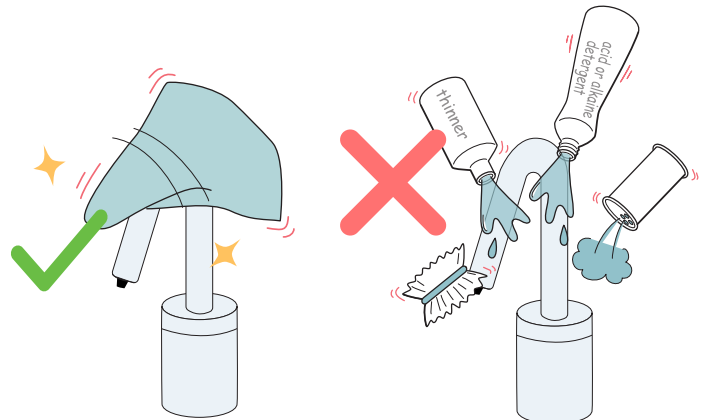

Hygienic

The proximity sensor removes the need to touch the spout body, reducing the spread of germs and reducing the chance of cross infection.

For more details, visit the product page:

